

# INSTALL DWG

# TOWN AND PARK FURNITURE



## WBTD 'METRO' WIDE BENCH (WBTD/LF Legfoot, WBTD/SP Surface post and WBTD/SS Sub-surface mount) (x 2.0m)

Install bench in above or below ground situations using 4 **stainless steel** 8mm stud (max.10mm) chemical or expansion anchors with 75-100mm penetration into concrete footing. **\*Do not exceed max. 10mm stud size as socket access is limited within integral bolthole recesses.** For important details on expansion and chemical anchors see **anchoring recommendations.**

- A SURFACE MOUNT:** Install unit direct to concrete pavement.
- B SURFACE MOUNT:** Install unit through pavers (on cement mortar bed) onto sub-surface footings\*.
- C SUB-SURFACE MOUNT:** Install unit onto sub-surface footings\* (using **stainless steel** washers as shims to adjust vertical alignment if required).

\*Suggested minimum sub-surface footings for **WBTD/LF Legfoot, WBTD/SP Surface post and WBTD/SS Sub-surface post:** 650 (L) x 200 (W) x 200 (D) **subject to on-site ground conditions.**

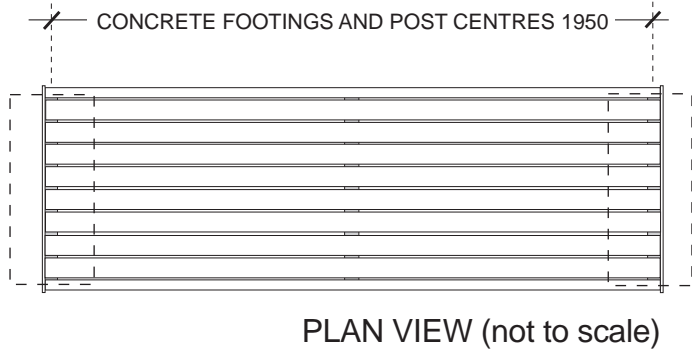
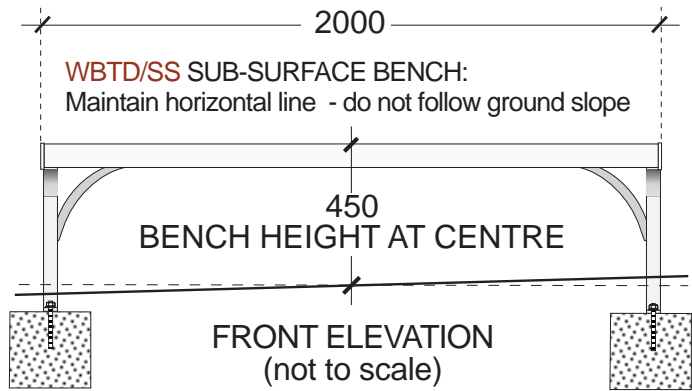

WBTD/LF

### END ELEVATIONS

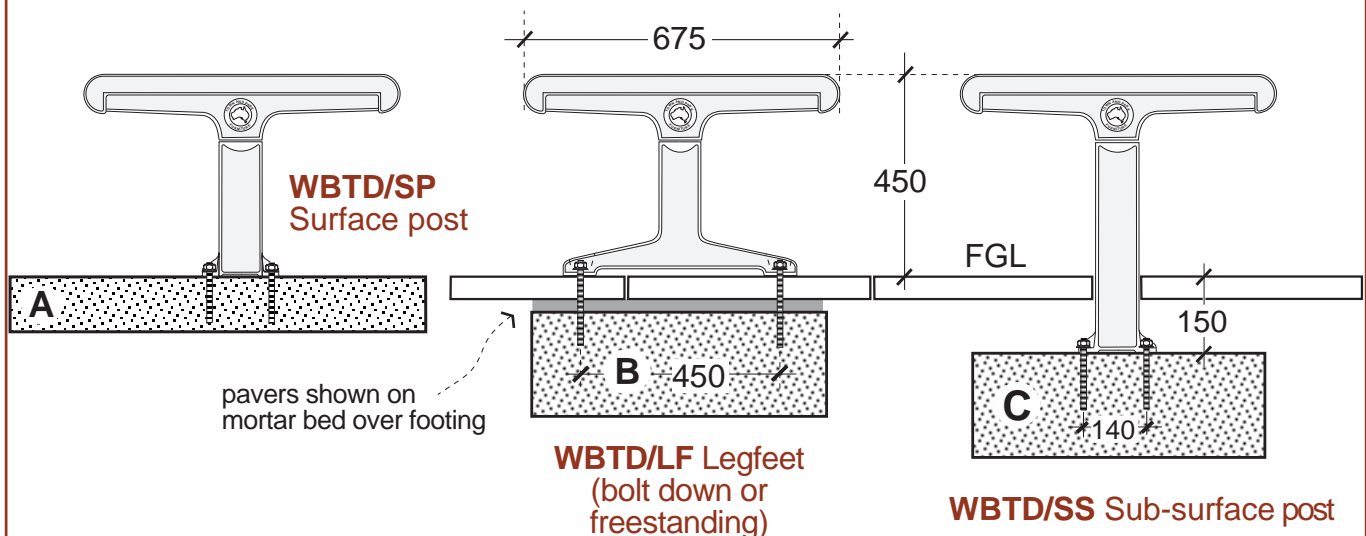

LAST UPDATED: 8.05



## ANCHORING RECOMMENDATIONS:

Town and Park Furniture recommends the use of **stainless steel** masonry anchors ONLY, with chemical or expansion anchors being the preferred methods.

The following anchor installation summary gives recommendations re hole preparation, anchor installation and securing of the fixture: **\*Do not exceed the max. stud size recommended for each product type as socket access may be limited within integral boltholes recesses. Refer to individual product install drawings for max. stud size recommendations:**

### 1. TYPICAL HOLE PREPARATION:

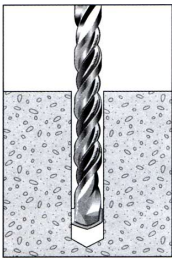

Drill hole using correctly sized rotary hammer carbide bit to the specified depth in solid substrate.

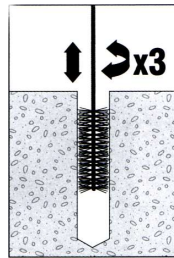

a) Clean hole with correct size hole cleaning brush with stiff nylon or wire bristles. Using a push/pull and twisting motion, ensure the sides of the hole are scrubbed at least 3 times for full depth of hole.

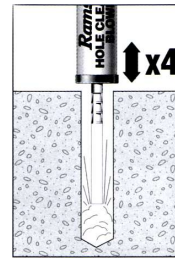

b) Remove debris, dust etc. from the hole using a hole cleaning blower with at least 4 swift pumps. Alternatively, a strong blast of compressed air may be used.

### 2. ANCHOR INSTALLATION:

#### EXPANSION ANCHOR

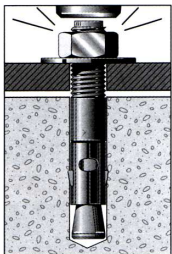

Insert anchor into hole flush against fixture.

#### CHEMICAL ANCHOR

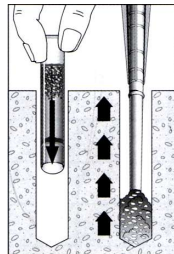

a) Insert correct sized chemical capsule or inject chemical mortar without creating air pockets in the hole.

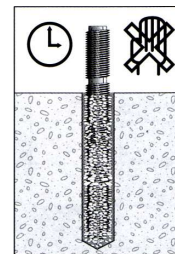

b) Drive stud to bottom of hole. Do not move the stud while chemical mortar is curing. See manufacturers data for setting times.

### 3. SECURING THE FIXTURE:

#### EXPANSION ANCHOR

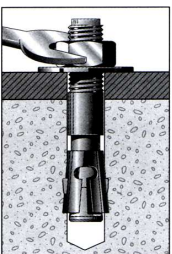

Tighten with a spanner. For optimum anchor performance use a torque wrench.

#### CHEMICAL ANCHOR

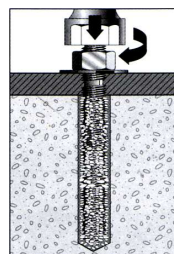

Attach fixture and tighten nut in accordance with recommended tightening torque.

The above anchor installation summary has been kindly provided by: RAMSET Fasteners (Australia) Pty Ltd. For further information including full technical data sheets visit..... [www.ramset.com.au](http://www.ramset.com.au)